

PRODUCT SPECIFICATION

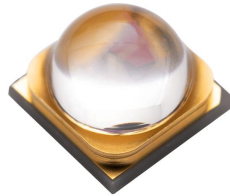

Part No. : JH-5050R6G42-T8A-J685
High Power LED

Catalog

1.Product Features	P2
2.Dimensions	P2
3.Absolute Maximum Rating	P3
4.Optical Character	P3
5.Optical Character Curves	P4
6.Spectrum Curves	P5
7.Viewing Angle Curves	P5
8.Tape&Reel Packing	P6
9.Soldering Advice	P7
10.Cautions	P8

1.Product Features

- High Brightness Red LED
- Round Package
- Viewing Angle 60 Degree
- Chip Material: AlGaInP
- RoHS Compliant

2.Dimensions

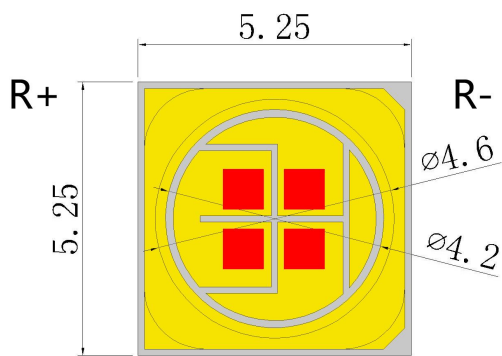

Top view

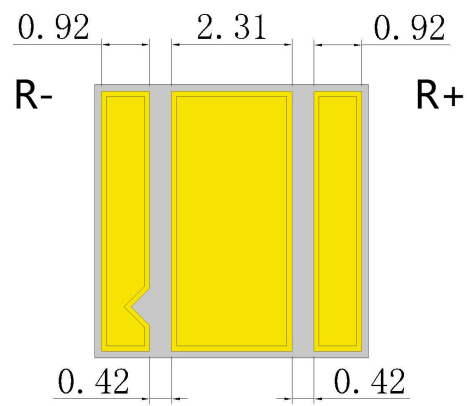

Bottom view

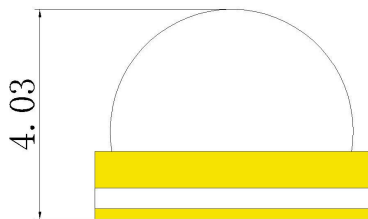

Side view

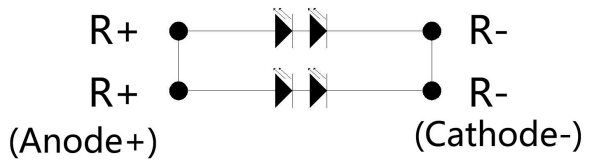

Circuit diagram

Notes:

1. All dimensions are in millimeters.
2. Tolerance is $\pm 0.1\text{mm}$ unless otherwise noted.

3. Absolute Maximum Rating @ Ta=25° C

Parameter	Symbol	Maximum Rating	Unit
Continuous Forward Current	IF	700	mA
Peak Forward Current (1/10 Duty Cycle, 0.1ms Pulse Width)	IFp	1400	mA
Reverse Voltage	VR	5	V
Power Dissipation	PD	12	W
Electrostatic Discharge	ESD	1000	V
Operating Temperature Range	TOPR	-25°C to +60°C	
Storage Temperature Range	TSTG	-35°C to +80°C	
Lead Soldering Temperature	TSOL	260°C	

4. Optical Character @ Ta=25° C

Parameter	Symbol	Color	Min.	Typ.	Max.	Unit	Test Condition
Forward Voltage	VF	R	4		4.5	V	IF=700mA
Luminous Flux	Φ	R	30	35	40	Lm	IF=700mA
Wavelength	WIP	R	680	683	685	nm	IF=700mA
Reverse Current	IR				10	μA	VR=5V
Viewing Angle	2θ1/2				60	deg	IF=700mA
Recommend Forward Current	IF(rec)	R			700	mA	

Notes:

Measurement tolerance of forward voltage ±0.1V

5. Optical Character Curves

(25 ° Ambient Temperature Unless Otherwise Noted)

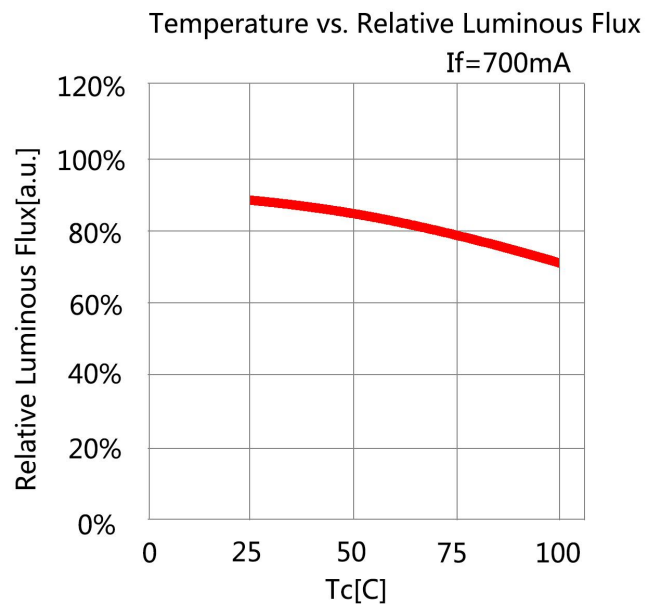
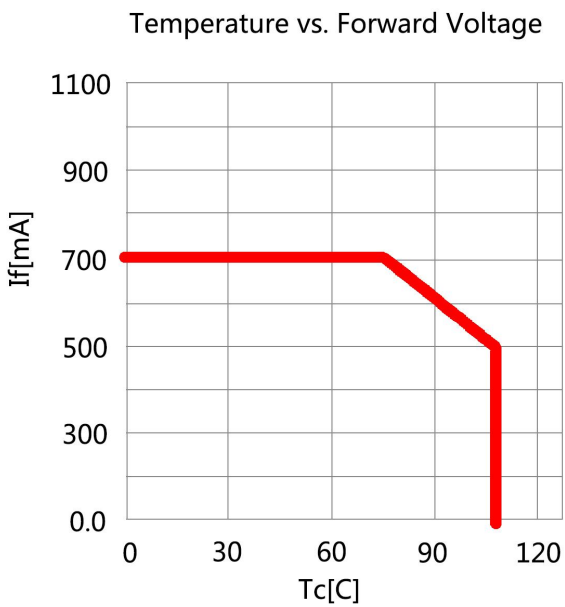
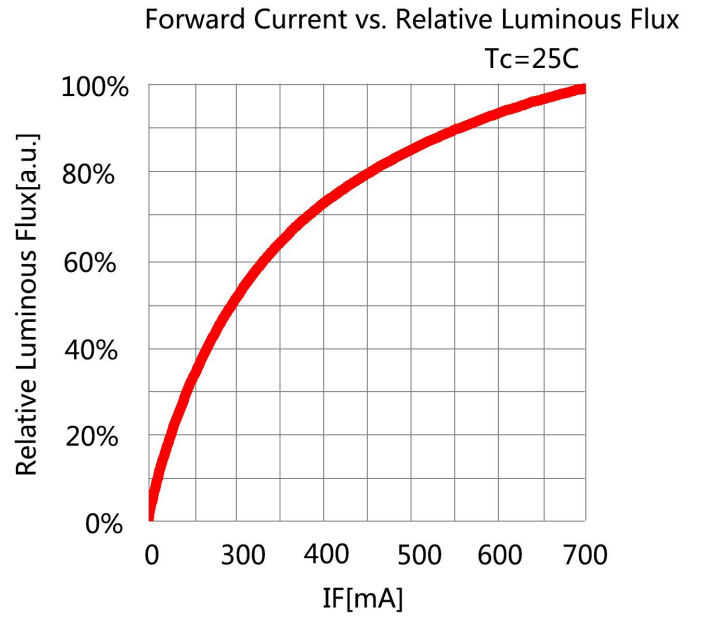
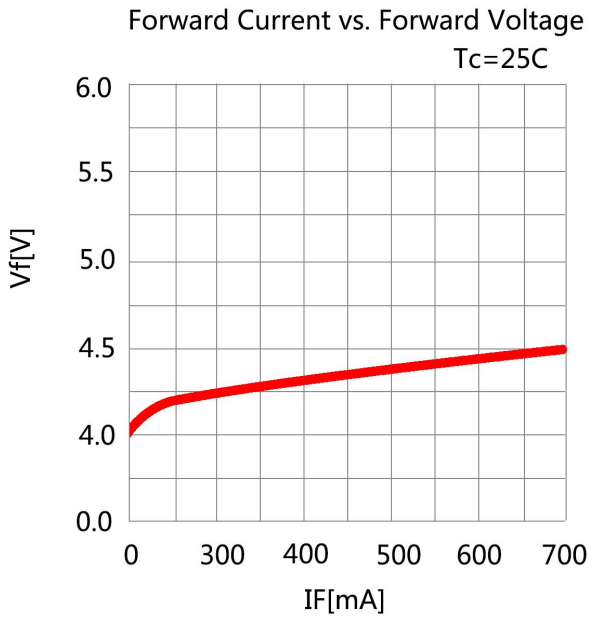

6. Spectrum Curves

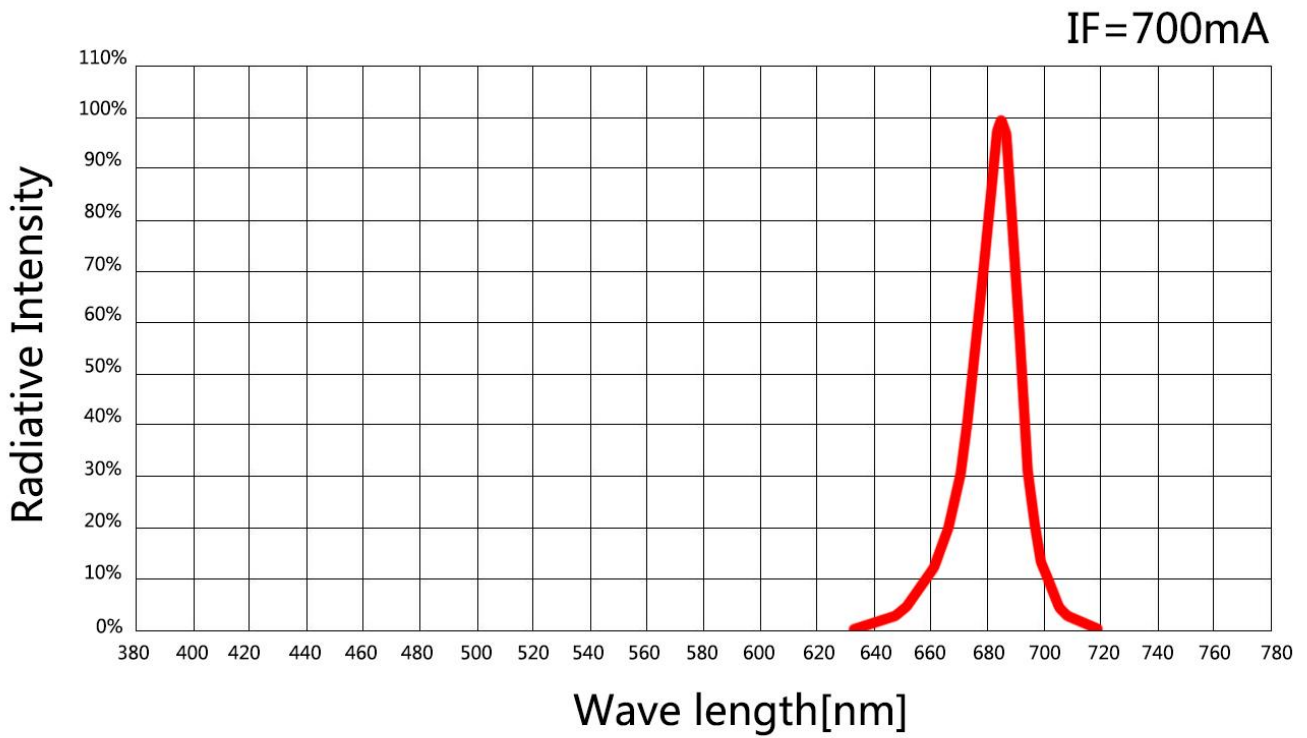

7. Viewing Angle Curves

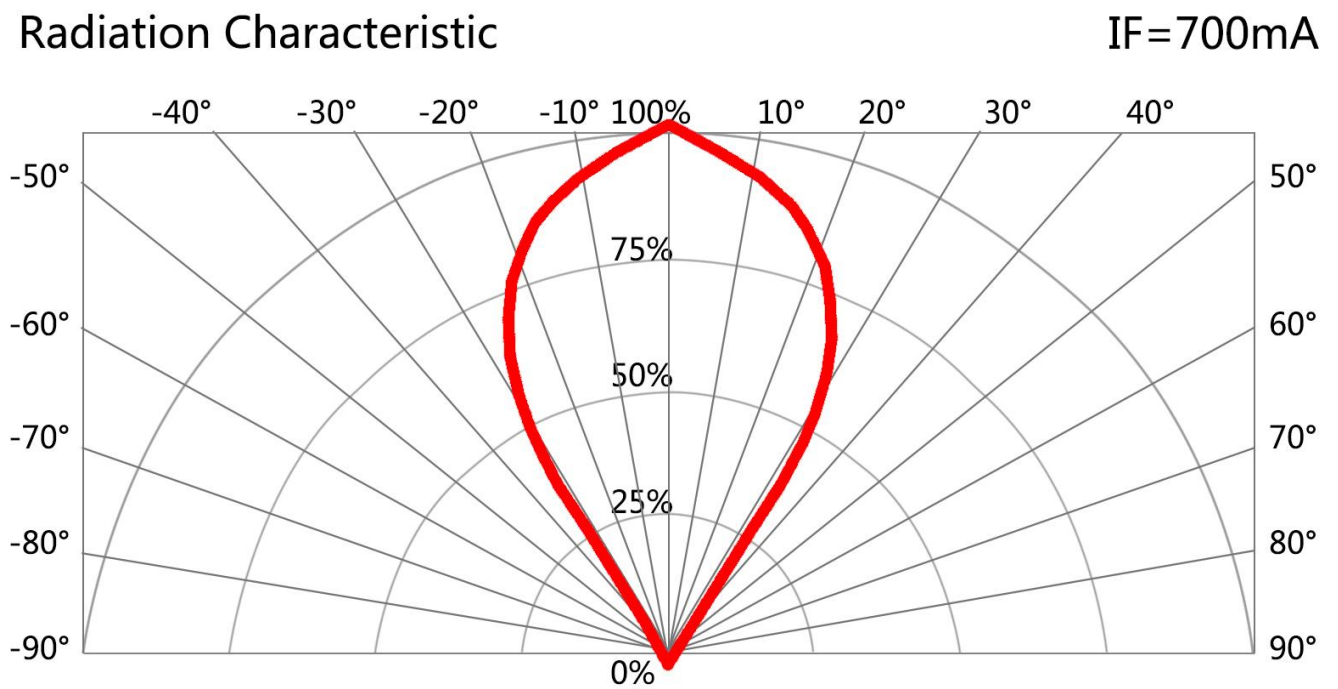

8. Tape & Reel Packing

1. Recommend unpacked LED beads be welded within one day, if not, please vacuumize again and store in an environment of 20-35°C and 30-60% humidity. If can't vacuumize, please store LED beads in moisture proof box, control at 25°C ± 3°C, humidity 50-60%. If unpacked above 1 week, bake at 60 ± 5°C for 10-12 hours before weld.

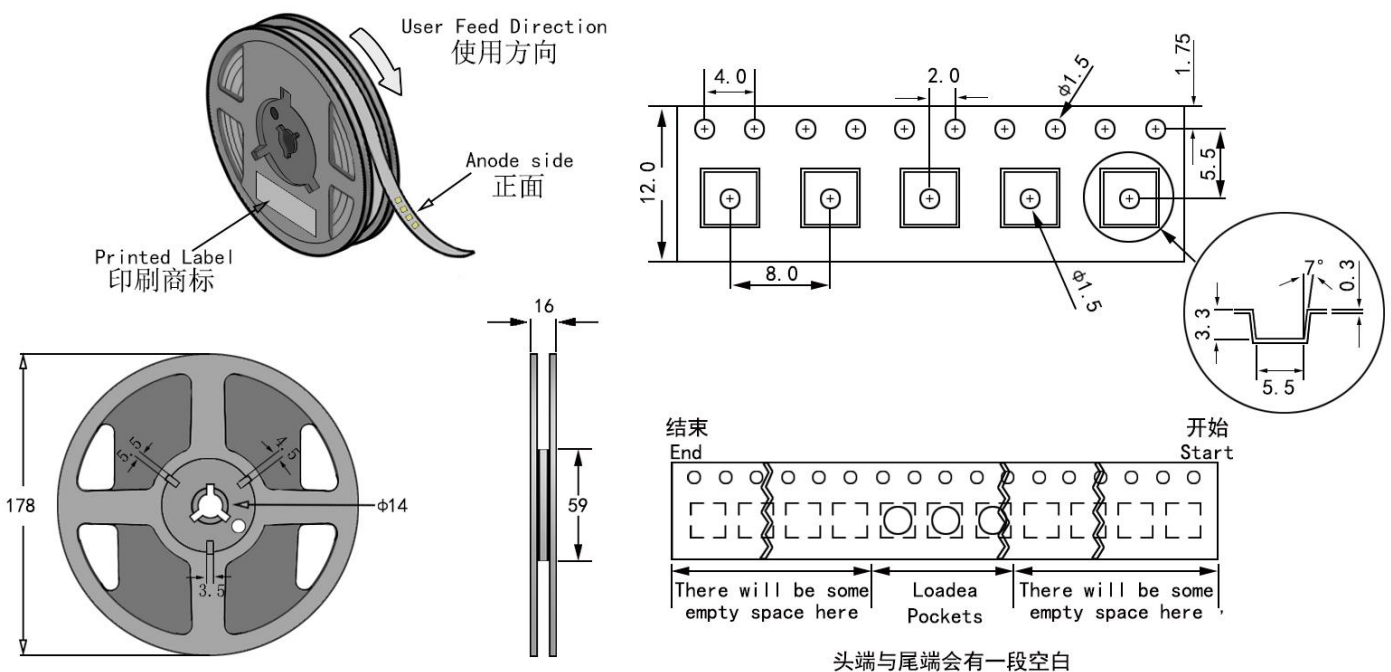

Notes:

1. QTY: 500pcs/Reel
2. Tolerance ±0.2mm.
3. Package: P/N

9.Soldering Advice

1. When soldering, don't touch the LED appearance gel during, this bad operation will destroy the LED. Moding LED usually use reflow soldering, please refer to the following reflow temperature curve , and recommend the user follow the soldering temperature curve of the solder paste.

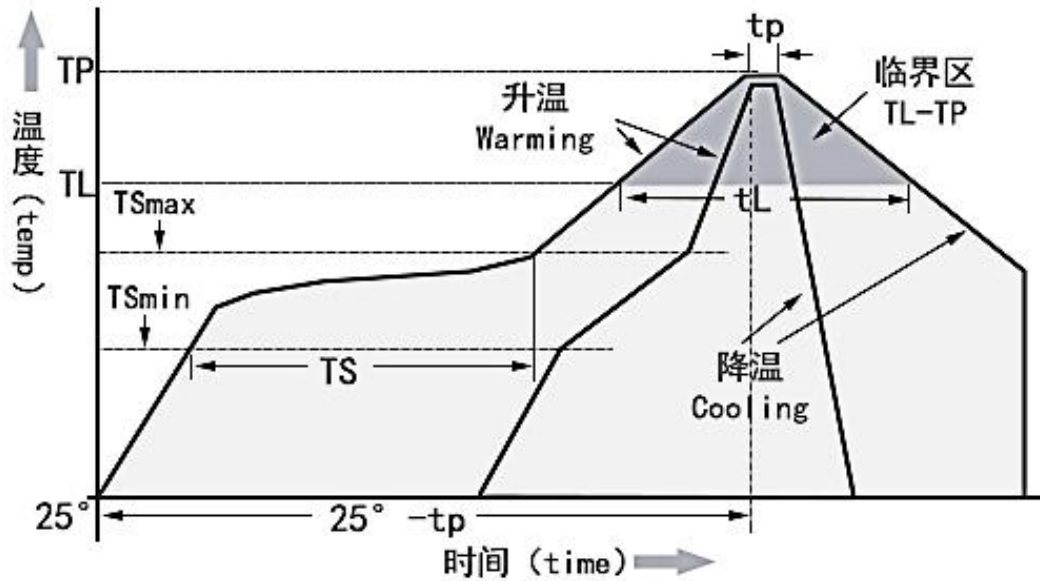

Temperature Curve Character	Lead-free solder
Average heating rate(TSmin to Tp)	最高 3°C/秒 Top 3 °C / s
Preheating: Minimum temperature (TSmin)	90°C
Preheating: Maximum temperature (TSmax)	200°C
Preheating: Time (TSmin to TSmax)	60-180 s
Duration above temperature: Temperature TL	240°C
Duration above temperature: Time tL	60-150 s
Peak/classification temperature (Tp)	260°C
Time within 5°C of actual peak temperature (tp)	20-40 s
Cooling speed	最高 6°C/秒 The highest 6 °C / s
Time to reach peak temperature at 25°C	最多 8 分钟 8 minutes Max

10. Cautions

1. Electrostatic Treatment

Do a full range of anti-static measures (such as: anti-static ring, anti-static clothes, machine, equipment grounding wire, etc.)



2. Heat Dissipation

- A、 It is recommend to configure reasonable heat dissipation device for the product.
- B、 The best working temperature range of the product is 40-60°. It is recommended to control the working temperature of the product within a reasonable range.

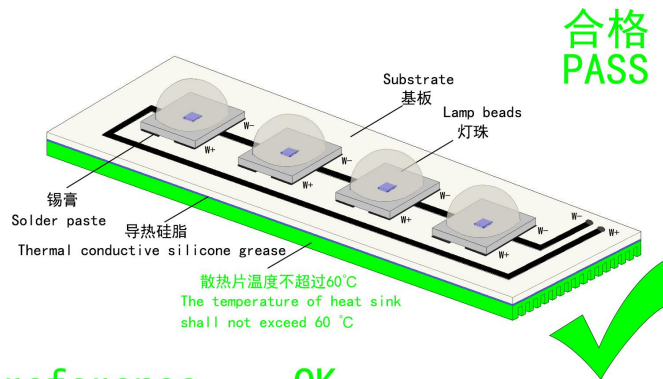

3. Installation Conditions

reference OK

A、 Do not exert any pressure on the LED area during the use of the led beads. If the machine is used to take materials, select a suction nozzle of reasonable size, such as below :

